

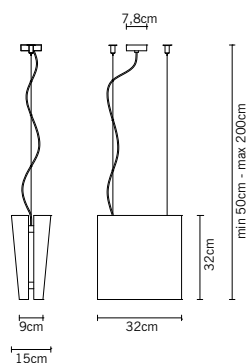

Clap F08

design Jacopo della Fontana



F08 A01

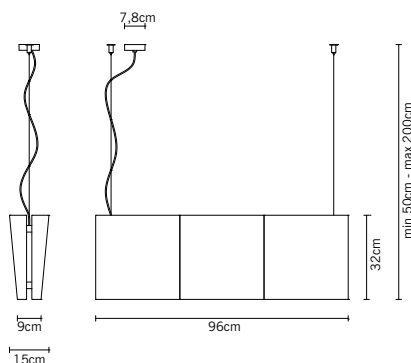

F08 A03

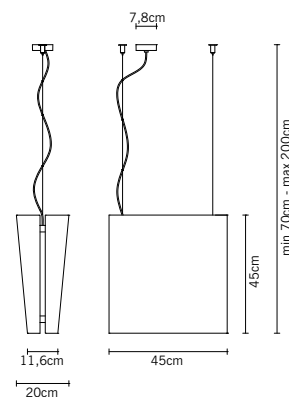

F08 A05

colore colour	15	15	15
tipologia tipology			
prezzo € price €	414,00	1.126,00	598,00
lamp. consigliata (non incl.) suggested bulb (not incl.)	A10212C10	A10212C10	A10213C10
prezzo lampadine € bulb price €	10x15,80	10x15,80	10x18,50
scheda tecn. elettrificazione electrification information	E27 2x15W FBG	E27 3x15W FBG	E27 2x20W FBG
volume (m³) / peso (kg) volume (m3) / weight (kg)	m³ 0,075 - kg 9,00	m³ 0,105 - kg 12,00	m³ 0,075 - kg 9,00
informazioni tecniche technical information	IP 20	IP 20	IP 20

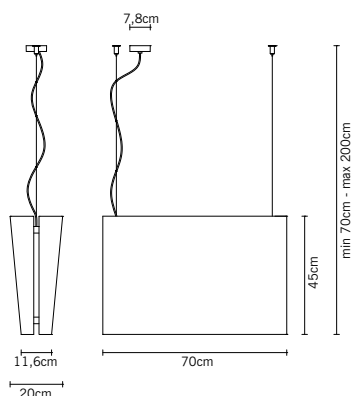

F08 A07

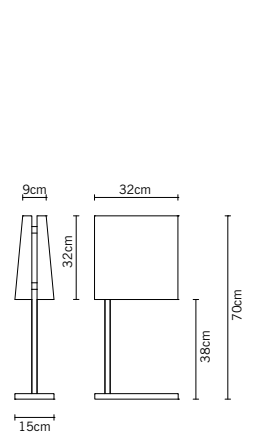

F08 B01

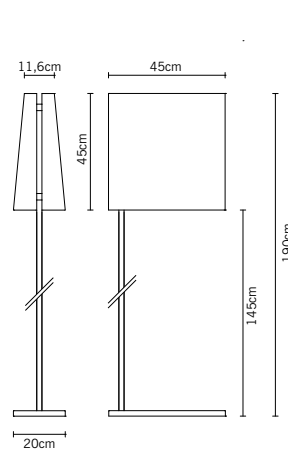

F08 C01

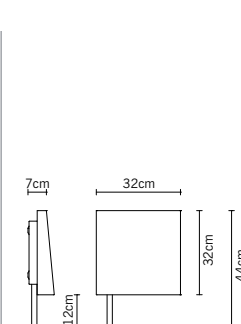

F08 D01

colore colour	15	15	15	15
tipologia tipology				
prezzo € price €	786,00	584,00	920,00	238,00
lamp. consigliata (non incl.) suggested bulb (not incl.)	A10213C10	A10212C10	A10213C10	A12301C01
prezzo lampadine € bulb price €	10x15,80	10x15,80	10x18,50	1x40,80
scheda tecn. elettrificazione electrification information	E27 3x20W FBG	E27 2x15W FBG	E27 2x20W FBG	GRZ10d 1x18W FSS
volume (m³) / peso (kg) volume (m3) / weight (kg)	m³ 0,105 - kg 12,00	m³ 0,075 - kg 9,00	m³ 1,35 - kg 19,00	m³ 0,055 - kg 8,00
informazioni tecniche technical information	IP 20	IP 20	IP 20	IP 20

Mochi F07

design A. Saggia Et V. Sommella

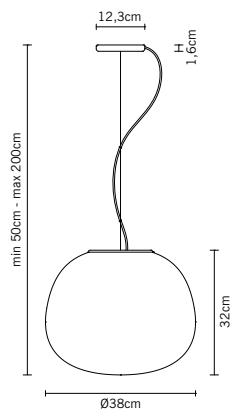

F07 A01

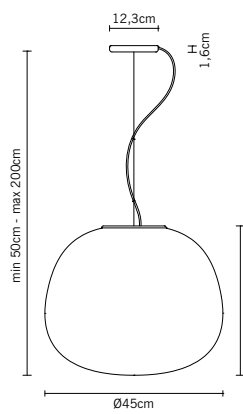

F07 A03

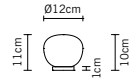

F07 B01

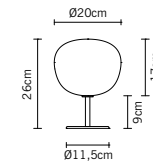

F07 B03

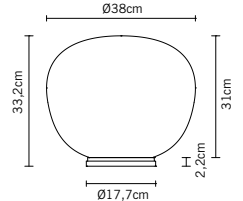

F07 B05

colore colour	01		01		01		01		01	
tipologia typology										
prezzo € price €	277,00		347,00		107,00		179,00		248,00	
lamp. consigliata (non incl.) suggested bulb (not incl.)	A10208C12	A10218C10	A10209C12	A10218C10	A11001C20	A11003C20	A10208C12	A10218C10	A10208C12	A10218C10
prezzo lampadine € bulb price €	12x18,24	10x32,64	12x18,24	10x32,64	20x4,80	20x4,80	12x18,24	10x32,64	12x18,24	10x32,64
scheda tecn. elettrificazione electrification information	E27 Max 1x150W HSGST	E27 Max 1x30W FBT	E27 Max 1x205W HSGST	E27 Max 1x30W FBT	G9 Max 1x20W HSGS	G9 Max 1x48W HSGS	E27 Max 1x150W HSGST	E27 Max 1x30W FBT	E27 Max 1x150W HSGST	E27 Max 1x30W FBT
volume (m³) / peso (kg) volume (m3) / weight (kg)	m³ 0,12 - kg 5,50		m³ 0,15 - kg 7,50		m³ 0,025 - kg 1,50		m³ 0,03 - kg 3,00		m³ 0,12 - kg 7,00	
informazioni tecniche technical information	IP20		IP20		IP40		IP40		IP40	

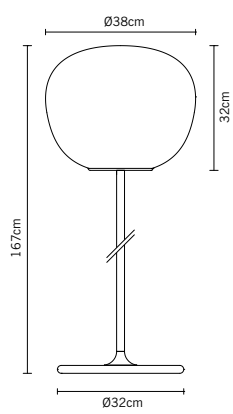

F07 C01

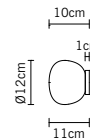

F07 G01

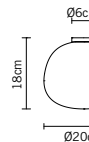

F07 E01

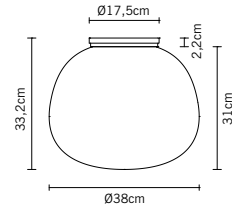

F07 E03

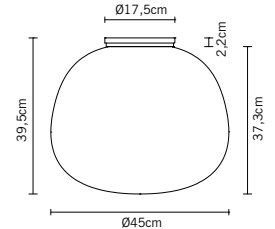

F07 E05

colore colour	01		01		01		01		01	
tipologia typology										
prezzo € price €	594,00		102,00		132,00		232,00		301,00	
lamp. consigliata (non incl.) suggested bulb (not incl.)	A10208C12	A10218C10	A11001C20	A11004C20	A10208C12	A10218C10	A10209C12	A10218C10	A10209C12	A10218C10
prezzo lampadine € bulb price €	12x18,24	10x32,64	20x4,80	20x4,80	12x18,24	10x32,64	12x18,24	10x32,64	12x18,24	10x32,64
scheda tecn. elettrificazione electrification information	E27 Max 1x150W HSGST	E27 Max 1x30W FBT	G9 Max 1x20W HSGS	G9 Max 1x60W HSGS	E27 Max 1x150W HSGST	E27 Max 1x30W FBT	E27 Max 1x205W HSGST	E27 Max 1x30W FBT	E27 Max 1x205W HSGST	E27 Max 1x30W FBT
volume (m³) / peso (kg) volume (m3) / weight (kg)	m³ 1,35 - kg 15,00		m³ 0,025 - kg 1,50		m³ 0,03 - kg 3,00		m³ 0,15 - kg 7,50		m³ 0,15 - kg 7,50	
informazioni tecniche technical information	IP40		IP40		IP40		IP40		IP40	

No More F06

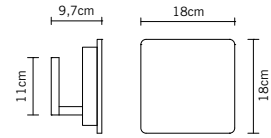
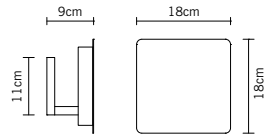

design Pio Et Tito Toso

F06 D01

F06 D03

colore
colour

01

69 70 48

tipologia
typology



prezzo €
price €

128,00

167,00

lamp. consigliata (non incl.)
suggested bulb (not incl.)

A12301C01

A12301C01

prezzo lampadine €
bulb price €

1x40,80

1x40,80

scheda tecn. elettrificazione
electrification information

GRZ10d
1x18W
FSS



GRZ10d
1x18W
FSS



volume (m³) / peso (kg)
volume (m3) / weight (kg)

m³ 0,0125 - kg 1,80

m³ 0,0125 - kg 1,80

informazioni tecniche
technical information



Angle F05

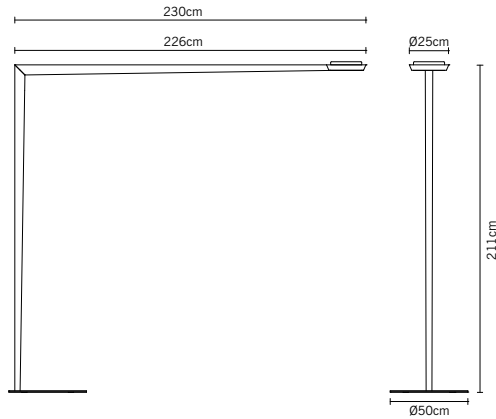

Pamio Design

F05 C01

colore
colour

01 02

tipologia
typology



prezzo €
price €

3.816,00

lampadina inclusa
included bulb

Led

prezzo lampadine €
bulb price €

scheda tecn. elettrificazione
electrification information

Microled
180 LED tot. 20W
1000 lumen
WHITE 3000K



volume (m³) / peso (kg)
volume (m3) / weight (kg)

m³ 1,35 - kg 20,00

informazioni tecniche
technical information



Tipologia
Topology

A
 Lampada a sospensione
 Hanging lamp

B
 Lampada da tavolo
 Table lamp

C
 Lampada da pavimento
 Floor lamp

D
 Lampada da parete
 Wall lamp

E
 Lampada da soffitto
 Ceiling lamp

G
 Lampada da parete e soffitto
 Wall and ceiling lamp

Codice colori
Colour codes
01
 Bianco
 White

02
 Nero
 Black

15
 Cromo
 Chrome

48
 Legno colore scuro
 Dark wood colour

69
 Legno colore chiaro
 Light wood colour

70
 Legno colore medio
 Intermediate wood colour

Marchi di sicurezza
Safety marks

 Apparato adatto al montaggio su superfici
 normalmente infiammabili.

Suitable for mounting on normally inflammable surface.

Accessori
Accessories

 Alimentatore elettronico
 Electronic ballast

 Led
 Led

Classe di isolamento
Class of insulation

 Ai fini della protezione elettrica, gli apparecchi sono
 classificati in base ad indicazioni CEE.

 For electric production purposes the fixtures are classified
 in accordance with EEC guidelines.

Classe I Isolamento funzionale in ogni parte, provvisto di
 messa a terra, o con morsetto se fisso o con conduttore e
 relativa spina con contatto di terra, se mobile.

Class I Functional insulation in every part and ground
 terminal or clamp in the unit is fixed, or with conductor
 and relative plug with ground contact if the unit is
 mobile.

Classe II Doppio isolamento e/o isolamento rinforzato in
 ogni parte e senza dispositivo di messa a terra.

Class II Double insulation and/or reinforced insulation in
 every part and without ground devices.

Grado di protezione IP
IP protection
IP20

 Protetto contro la penetrazione di corpi solidi di
 dimensioni maggiori a 12 mm. Non protetto nei
 confronti dei liquidi.

 Protected against entry of solid objects larger than
 12 mm.
 No protection against the ingress of water.

IP40

 Protetto contro la penetrazione di corpi solidi di
 dimensioni maggiori a 1 mm. Non protetto nei
 confronti dei liquidi.

 Protected against entry of solid objects larger than
 1 mm.
 No protection against the ingress of water.

Indice lampadine
Bulbs index

Lampadine Bulbs	Descrizione Description	Codice Code	Q.tà Qty	Potenza Power (W)	Attacco Socket	Flusso luce Light flux (lumen)	Temp. colore Light temp. (Kelvin)	Codice ILCOS L Code ILCOS L	Tipo Type	Prezzo € Price €
	alogeno chiara clear halogen	A10207C12 A10208C12 A10209C12	12 12 12	100 150 205	E27	1800 2870 4200	2900	HSGST	QT-32	12 x 18,24 12 x 18,24 12 x 18,24
	alogeno chiara clear halogen	A11001C20 A11002C20 A11003C20 A11004C20	20 20 20 20	20 33 48 60	G9	200 460 740 980	2900	HSGS	Halopin Bipin Hipin	20 x 4,80 20 x 4,80 20 x 4,80 20 x 4,80
	fluorescenza compatta compact fluorescent	A12301C01	1	18	GRZ10d	1150	3500	FSS	TC-DD	1 x 40,80
	fluorescenza elettronica fluorescent electronic	A10216C10 A10217C10 A10215C10 A10218C10	10 10 10 10	18 22 14 30	E27	1050 1410 800 1920	2500	FBT	Energy saving	10 x 32,64 10 x 32,64 10 x 32,64 10 x 32,64
	sfera fluorescente fluorescent sphere	A10212C10 A10213C10	10 10	15 20	E27	850 1160	2500	FBG		10 x 15,84 10 x 18,48

Italy

Fabbian Illuminazione Spa
Via Santa Brigida 50
31020 Castelminio di Resana
Treviso
tel. +39 0423 4848
fax +39 0423 484395
numero verde 800 800 444
www.fabbian.com

sales

italia@fabbian.com
export@fabbian.com
mkt & com
comunicazione@fabbian.com

Brasil

Fabbian Brasil
Rua Julio C. Riberio de Souza 331
Hauer 81610 -120
Curitiba, PR, Brasil
fone +55 41 3284 4000
fax +55 41 3284 4001
www.fabbian.com.br

sales

brasil@fabbian.com

USA e Canada

Fabbian Usa Corp.
161 Dwight Pl.
Fairfield, NJ 07004, USA
ph. +1 973 882 3824/3825
fax +1 973 882 3826
+1 866 Fabbian
www.fabbian.com

sales

usa@fabbian.com
canada@fabbian.com
mkt & com
marketing.usa@fabbian.com